

RMB20 encoder module with AM4096

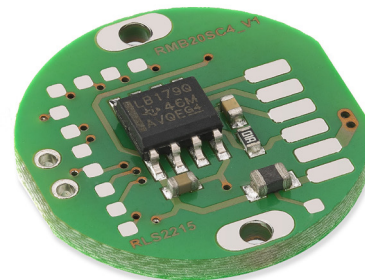
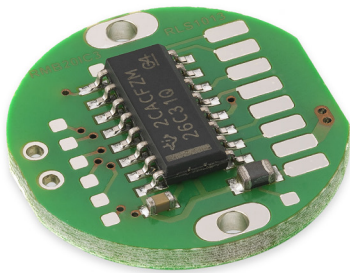

The RMB20 encoder module provides the functionality of the RM22 encoder in a compact component format for simple customer integration. With a PCB diameter of only 20 mm, the module fits into miniature designs.

The encoder module consists of a magnetic actuator and a separate sensor board. Custom encoder chip that is mounted on a sensor board reads and processes the rotation of magnetic actuator and gives the required output format. Output signals are provided in industry standard absolute, incremental, analogue, commutation and linear formats.

The RMB20 can be designed into equipment used in a wide range of applications including marine, medical, print, converting, industrial automation, motor control and instrumentation.

Product range

RMB20AC/BC

Analogue sinusoidal outputs with a single sine/cosine period per revolution.

RMB20IC

Incremental with 8 to 1024 pulses per revolution (32 to 4096 counts per revolution with x4 evaluation).

RMB20SC

Synchro serial interface (SSI) with 32 to 4096 positions per revolution.

The encoder module includes zeroing pads for setting the encoder zero position. The new zero position can be set by shorting the two zeroing pads.

- Price performance solution
- 20 mm diameter circular module
- 5 V power supply
- High speed operation to 60,000 rpm
- Absolute - up to 12 bit resolution
- Industry standard absolute and incremental output formats
- Accuracy to $\pm 0.5^\circ$

Installation drawing

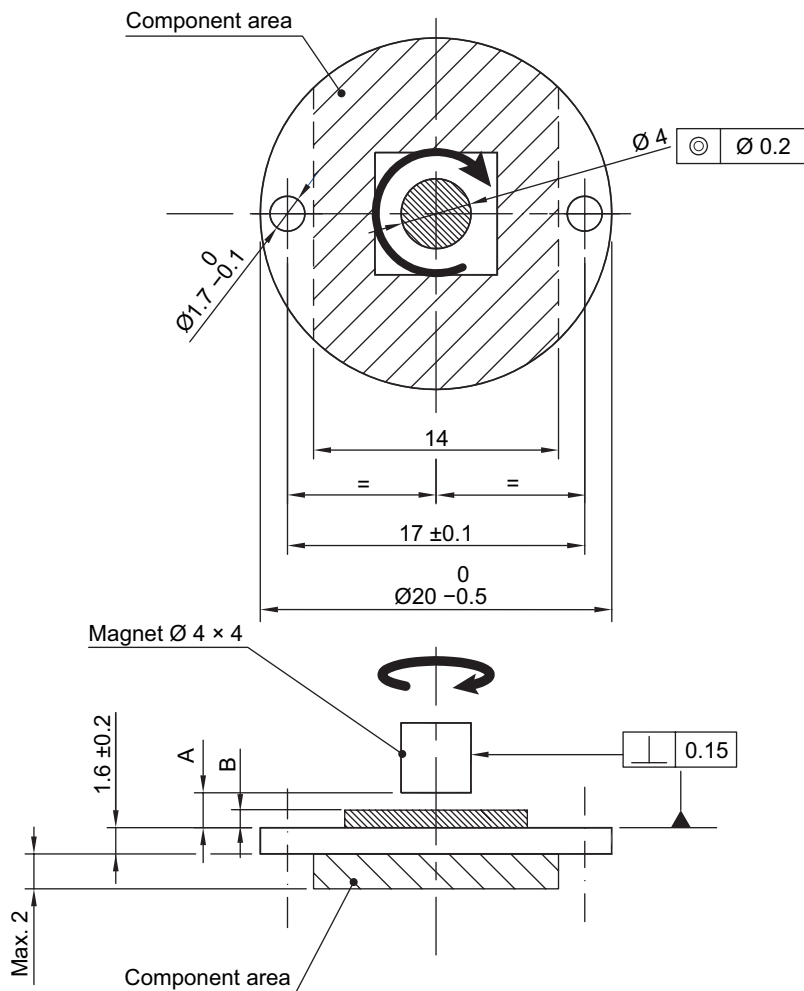

Module	A PCB surface to magnet distance [mm]	B Chip height [mm]
RMB20AC	2.30 ± 0.5	Max. 1
RMB20BC		
RMB20IC	2.8 ± 0.5	Max. 2
RMB20SC		

NOTE: For the accuracy specified, the central line of the magnet needs to be square to the chip within 2° and aligned within the center of the board ±0.1 mm (mid point between the two mounting holes).

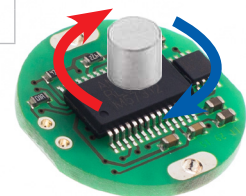

Clockwise (CW) rotation of magnet

Recommended signal termination

For digital data output lines only

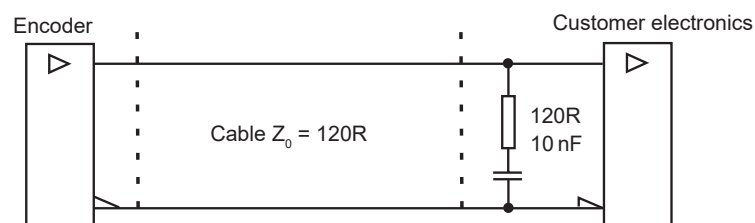

RMB20AC – Analogue sinusoidal outputs

2 channels V_A and V_B sinusoids (90° phase shifted, single ended)

Power supply	$V_{dd} = 5\text{ V} \pm 5\%$
Current consumption	30 mA
Outputs	Single ended
Signal amplitude	$2.2 \pm 0.2\text{ V}_{pp}$
Signal offset (Vref)	$2.5\text{ V} \pm 1\%$
Internal serial impedance	$10\ \Omega$
Maximum speed	60,000 rpm
Temperature Operating and storage	$-40\text{ }^\circ\text{C}$ to $+125\text{ }^\circ\text{C}$

Connections

RMB20AC

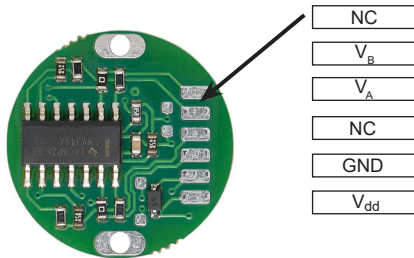

Timing diagram

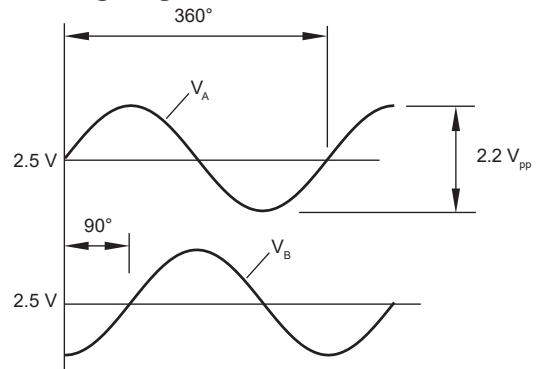

V_A leads V_B for clockwise rotation of magnet

RMB20BC – Analogue complementary sinusoidal outputs

2 channels V_A and V_B differential sinusoids

Power supply	$V_{dd} = 5\text{ V} \pm 5\%$
Current consumption	30 mA
Outputs	Differential
Signal amplitude	$0.5 \pm 0.1\text{ V}_{pp}$
Signal offset (Vref)	$0 \pm 5\text{ mV}$
Internal serial impedance	$10\ \Omega$
Maximum speed	60,000 rpm
Temperature Operating and storage	$-40\text{ }^\circ\text{C}$ to $+125\text{ }^\circ\text{C}$

Connections

RMB20BC

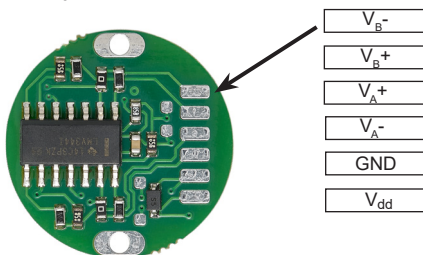

Timing diagram

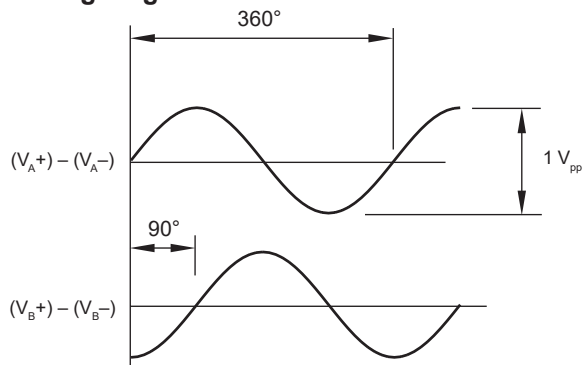

V_A leads V_B for clockwise rotation of magnet

RMB20IC – Incremental output

Square wave differential line driver to RS422

Power supply	$V_{dd} = 5\text{ V} \pm 5\%$
Current consumption	35 mA
Output signals	A, B, Z, A-, B-, Z- (RS422)
Resolutions	32, 64, 128, 256, 512, 1,024, 2,048, 4,096 cpr
Maximum speed	60.000 for resolutions up to 1,024 cpr 30.000 for 2,048 and 4,096 cpr
Accuracy	$\pm 0.5^\circ$
Hysteresis	0.18°
Temperature	-40 °C to +125 °C
Operating and storage	

Timing diagram

Complementary signals not shown

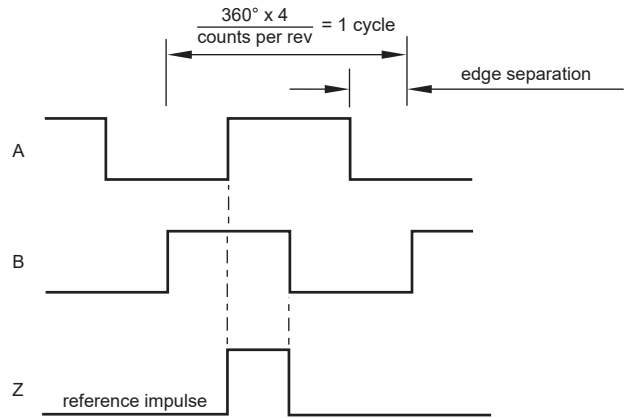

B leads A for clockwise rotation of magnet.

Connections

RMB20IC

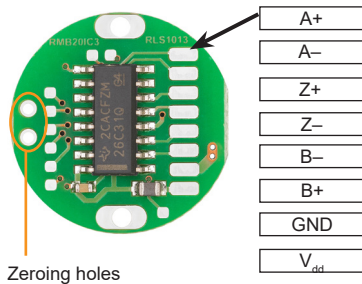

Zeroing holes

RMB20SC – Absolute binary synchro-serial interface (SSI)

Serial encoded absolute position measurement

Output code	Natural binary
Power supply	$V_{dd} = 5\text{ V} \pm 5\%$
Current consumption	35 mA
Resolutions	512, 1,024, 2,048, 4,096 positions per revolution
Repeatability	$\leq 0.07^\circ$
Data output	Serial data (RS422)
Data input	Clock (RS422)
Temperature	-40 °C to +125 °C
Operating and storage -40 °C to +105 °C (with connector)	

Timing diagram

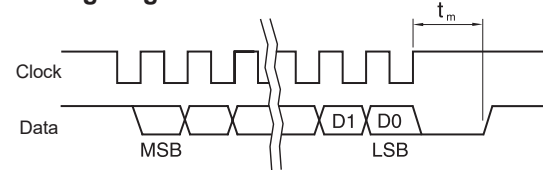

Clock $\leq 4\text{ MHz}$ $12.5\ \mu\text{s} \leq t_m \leq 20.5\ \mu\text{s}$

Position increases for clockwise rotation of magnet.

Connections

RMB20SC

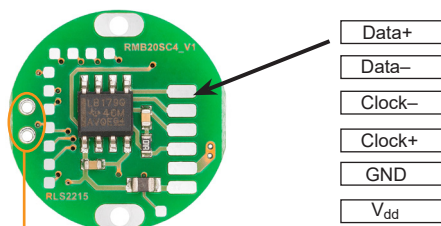

Zeroing holes

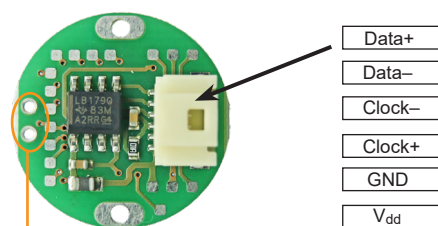

Zeroing holes

Connector type: Molex 501568-0607
Mating connector: Molex 501330-0600
Crimp terminal: 501334-0000

Zero position setting procedure

Encoder zero position can be easily set by shortening the zeroing pads on the board. After locking the motor at the mechanical zero position short together the two zeroing pads.

The output angle position data can be zeroed at any angle with resolution of 0.0879°.

RMB20 zeroing example

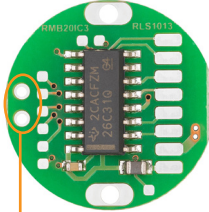

zeroing holes

The zeroing holes can be shorted to set the zero position of the encoder.

Part numbering

RMB20 IC 09B C 96

Output type

AC - Analogue sinusoidal
BC - Analogue complementary sinusoidal
IC - Incremental, RS422
SC - Absolute binary synchro-serial (SSI), RS422

Resolution

For **AC** and **BC**:

01S - one sine/cosine wave per revolution

For **IC** and **SC** (counts/positions per revolution):

05B - 32	08B - 256	11B - 2048
06B - 64	09B - 512	12B - 4096
07B - 128	10B - 1024	

Special requirements*

96 - With AM4096 - up to 12 bit
C6 - With Molex connector (for SC only)

Shape

C - Circular

* For sample quantities of RMB20 supplied with a magnet please add "KIT" to the end of the required RMB20 part number, eg. RMB20IC09BC96KIT.

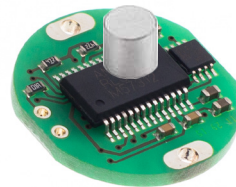

Magnetic actuator and magnet ordering information

Actuator for integration onto shaft

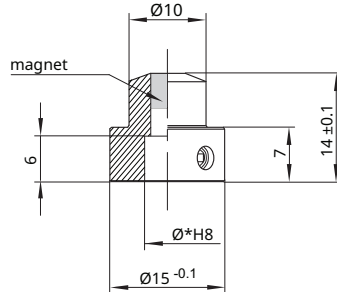

Shaft = Ø * h7

Fixing: Grub screw provided

* Hole diameter for nominal shaft size.
See table on the right for more information on available shaft sizes.

Part numbers:

For resolutions up to 9 bit absolute (512 cpr incremental)

RMA04A2A00 – Ø4 mm shaft	RMA10A2A00 – Ø10 mm shaft
RMA05A2A00 – Ø5 mm shaft	RMA19A2A00 – Ø3/16" shaft
RMA06A2A00 – Ø6 mm shaft	RMA25A2A00 – Ø1/4" shaft
RMA08A2A00 – Ø8 mm shaft	RMA37A2A00 – Ø3/8" shaft

For resolutions from 10 bit absolute (800 cpr incremental) and above

RMA04A3A00 – Ø4 mm shaft	RMA10A3A00 – Ø10 mm shaft
RMA05A3A00 – Ø5 mm shaft	RMA19A3A00 – Ø3/16" shaft
RMA06A3A00 – Ø6 mm shaft	RMA25A3A00 – Ø1/4" shaft
RMA08A3A00 – Ø8 mm shaft	RMA37A3A00 – Ø3/8" shaft

Actuator for integration into shaft

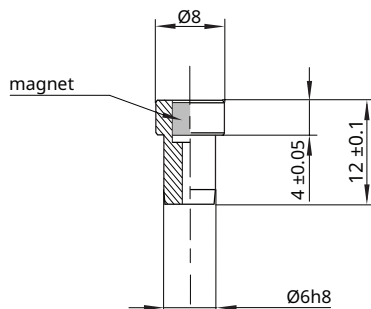

Hole = Ø6G7

Fixing: Glue (recommended – LOCTITE 648 or 2701)

Part numbers:

For resolutions up to 9 bit absolute (512 cpr incremental)

RMH06A2A00

For resolutions from 10 bit absolute (800 cpr incremental) and above

RMH06A3A00

With N-pole marker scribed to a ±5° accuracy:

For resolutions up to 9 bit absolute (512 cpr incremental)

RMH06A2A02

For resolutions from 10 bit absolute (800 cpr incremental) and above

RMH06A3A02

Magnet for direct recessing in non-ferrous shafts

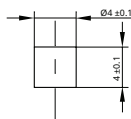

Fixing: Glue (recommended – LOCTITE 648 or 2701)

Part numbers:

For resolutions up to 9 bit absolute (512 cpr incremental)

RMM44A2A00 (individually packed) – for sample quantities only
RMM44A2C00 (packed in tubes)

For resolutions from 10 bit absolute (800 cpr incremental) and above

RMM44A3A00 (individually packed) – for sample quantities only
RMM44A3C00 (packed in tubes)

Accessories part numbering

Cable assembly with dual ended connectors

Cable specifications for connection of Molex 501330-0600

Part numbers	ACC028 (cable length: 30 cm)
Number of wires	6
Wire size	28 AWG
Wire insulation diameter	0.6 mm
Wire type	UL 1571
Connector	Molex 501330-0600
Crimp terminal	501334-0000
Mating connector type	Molex 501568-0607

Dimensions

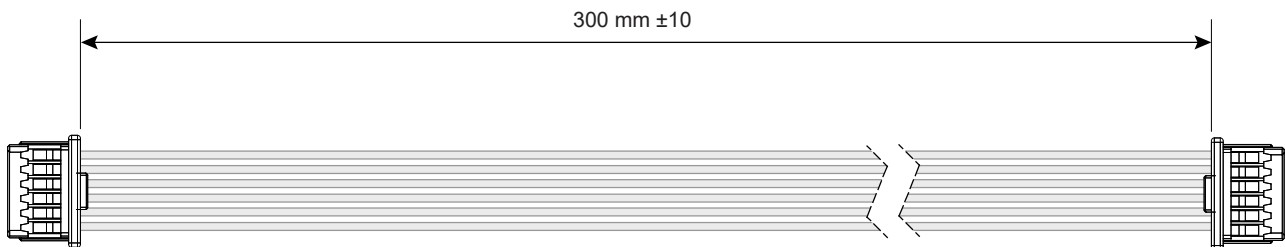

 MOLEX 501330-0600



Head office

RLS merilna tehnika d.o.o.
 Poslovna cona Žeje pri Komendi
 Pod vrbami 2
 SI-1218 Komenda
 Slovenia

T +386 1 5272100
F +386 1 5272129
E mail@rls.si
www.rls.si

Document issues

Issue	Date	Page	Amendments done
1	29. 4. 2016	-	New document
2	14. 7. 2016	3	Zeroing pads added
3	2. 6. 2017	1	RoHS logo added
		4	Zeroing procedure added
4	26. 3. 2019	3	Molex connector for RMB20SC added
5	30. 8. 2019	2	Dimensions drawing amended
		6	Cable accessories amended
6	27. 9. 2021	2	Dimensions drawing amended
		3	Temperature SC amended
7	6. 12. 2021	1, 2, 3, 5	AC / BC output added
8	10. 3. 2022	3	AB / BC output amended

This product is not designed or intended for use outside the environmental limitations and operating parameters expressly stated on the product's datasheet. Products are not designed or intended for use in medical, military, aerospace, automotive or oil & gas applications or any safety-critical applications where a failure of the product could cause severe environmental or property damage, personal injury or death. Any use in such applications must be specifically agreed to by seller in writing, and is subject to such additional terms as the seller may impose in its sole discretion. Use of products in such applications is at buyer's own risk, and buyer will indemnify and hold harmless seller and its affiliates against any liability, loss, damage or expense arising from such use. Information contained in this datasheet was derived from product testing under controlled laboratory conditions and data reported thereon is subject to the stated tolerances and variations, or if none are stated, then to tolerances and variations consistent with usual trade practices and testing methods. The product's performance outside of laboratory conditions, including when one or more operating parameters is at its maximum range, may not conform to the product's datasheet. Further, information in the product's datasheet does not reflect the performance of the product in any application, end-use or operating environment buyer or its customer may put the product to. Seller and its affiliates make no recommendation, warranty or representation as to the suitability of the product for buyer's application, use, end-product, process or combination with any other product or as to any results buyer or its customer might obtain in their use of the product. Buyer should use its own knowledge, judgment, expertise and testing in selecting the product for buyer's application, end-use and/or operating environment, and should not rely on any oral or written statement, representation, or samples made by seller or its affiliates for any purpose. EXCEPT FOR THE WARRANTIES EXPRESSLY SET FORTH IN THE SELLER'S TERMS AND CONDITIONS OF SALE, SELLER MAKES NO WARRANTY EXPRESS OR IMPLIED WITH RESPECT TO THE PRODUCT, INCLUDING ANY WARRANTY OF MERCHANTABILITY OR FITNESS FOR ANY PARTICULAR PURPOSE, WHICH ARE DISCLAIMED AND EXCLUDED. All sales are subject to seller's exclusive terms and conditions of sale which, where the seller is (a) RLS merilna tehnika d.o.o., are available at <https://www.rls.si/customer-service>, (b) Renishaw, Inc., are available at <http://www.renishaw.com/Shop/legal/en/-42186>, or (c) another person, are available on request, and in each case, are incorporated herein by reference, and are the exclusive terms of sale. No other terms and conditions apply. Buyer is not authorized to make any statements or representations that expand upon or extend the environmental limitations and operating parameters of the products, or which imply permitted usage outside of that expressly stated on the datasheet or agreed to in writing by seller.

RLS merilna tehnika d.o.o. has made considerable effort to ensure the content of this document is correct at the date of publication but makes no warranties or representations regarding the content. RLS merilna tehnika d.o.o. excludes liability, howsoever arising, for any inaccuracies in this document. © 2022 RLS d.o.o.