

E201

USB Encoder Interface

The E201 is a single-channel USB encoder interface suitable for use with a wide variety of rotary and linear encoders. It allows encoders to be easily interfaced and powered from a PC using only a USB cable. The product is available in 4 different options for different encoder communication interfaces.



Features and benefits

- ▶ Can be used for a variety of applications
- ▶ Easy to use with USB
- ▶ Pin compatibility with RLS encoders
- ▶ Status LED indicators
- ▶ Compatibility with absolute and incremental encoders
- ▶ 5 V power supply

General information

Choose your E201 USB encoder interface

E201-9Q



For use with incremental encoders.

E201-9S



For use with absolute SSI encoders and unidirectional communication for absolute BiSS C encoders.*

E201-9B



For use with absolute BiSS C bidirectional encoders.

E201-9P



For use with absolute encoders with SPI or PWM communication interface.

* E201-9S also works with bidirectional BiSS C encoders (AksIM-2 and AksIM-4, Orbis), but using E201-9B provides more features.

COMPATIBLE ENCODERS	E201-9Q	E201-9S	E201-9B	E201-9P
AksIM-2 & AksIM-4		✓	✓	✓
Artos	✓**	✓		
LA11		✓		✓
LinACE		✓		
LM10	✓			
LM13	✓			
Orbis		✓	✓	
RE22/36	✓	✓		
RLB	✓			
RLM	✓			
RM22/36	✓	✓		
RM44/58	✓	✓		
SpinCo	✓			

** Only with PCB-A for DI and SI option.

Applications

The E201 is intended for applications such as functional testing, configuration, commissioning and diagnostics of encoders, metrology, gauging and PC-based machinery.

What you need

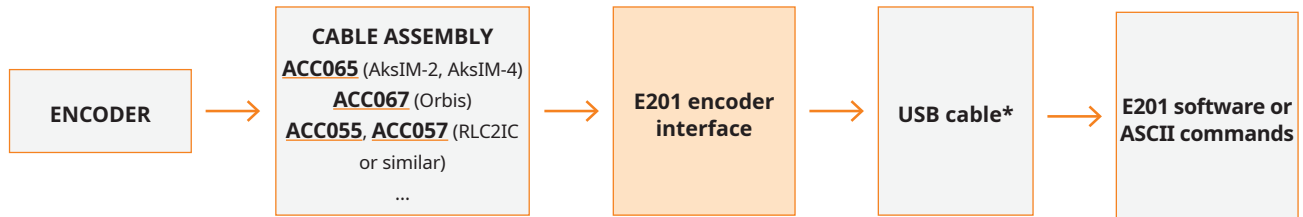

* Supplied with E201 interface.

E201 dimensions

Dimensions and tolerances in mm.

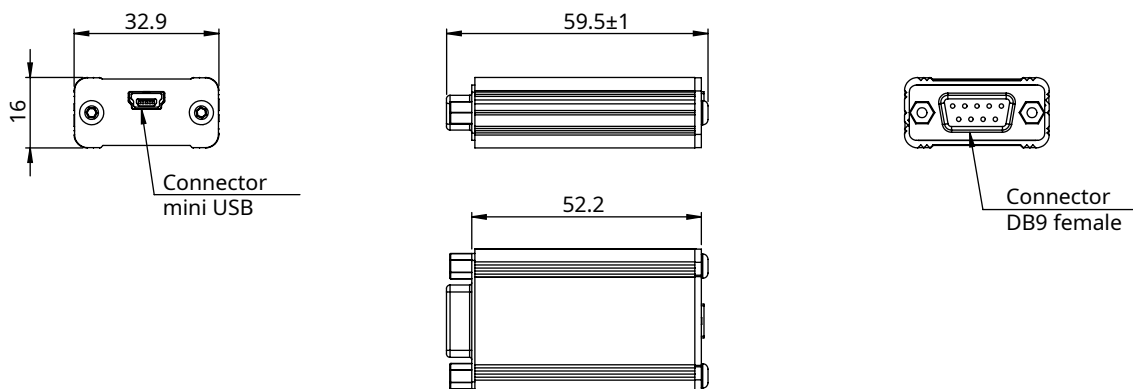

E201-9Q – for 5 V incremental encoders

The E201-9Q counts edges from 5 V incremental encoders and allows the count value to be read by a PC using simple ASCII commands over the USB connection.

Software installation

Download and install the [Software for E201-9Q and E201-9S](#). To install drivers, follow the steps in the following chapter. When the installation is complete, connect the E201 interface and configure the software for the encoder you are using. The supply voltage and current consumption of the encoder can be read by the software. The encoder's power supply can be turned on and off by the software.

A detailed explanation of the ASCII commands for the development of customised software can be found in chapter [Command set](#).

Installing the USB drivers

USB drivers for Windows 10 or newer, use Windows Update to install the "Inbox drivers". For more information see [link](#). For Windows 8 or older, or if the installation of the Inbox driver fails, the drivers must be downloaded from [RLS Media center](#).

The E201 interface appears as a new Virtual COM port on the computer. The actual port number assigned depends on how many COM ports are already in use on the PC.

In Windows you can find this under:

Control Panel > System > Device Manager > Ports (COM & LPT)

Supported operating systems: 32-bit and 64-bit Windows (XP, Vista, 7 and 8/8.1, 10, 11) Linux and Mac OS X. The E201 USB interface should be automatically detected on Linux and Mac OS X.

It uses the "Communication Device Class driver (CDC)".

VID = 0483 & PID = 5740

Technical specifications

Power supply	5 V over USB port
Power consumption	65 mA (without encoder connected)
Encoder power supply	5 V or lower as supplied from the computer. Consider voltage drop over USB cable, USB hubs and encoder cable. Output is fused.
Inputs	RS422 differential A, B, Z, A-, B-, Z-
Maximum count rate	10 MHz, if using reference marks 40 MHz, if not using reference marks
Encoder connector	D-Sub 9 pin, female
USB connector	USB 1.1 Full Speed; USB 5 pin mini-B connector
Drivers	Windows, Linux, Mac
Cable length	1 m standard A to mini-B USB cable (supplied). Maximum length 5 m.
Operating temperature	0 °C to +45 °C
Environmental sealing	IP20 - indoor use only
Mass	42 g (interface without USB cable)

Status LEDs

LED colour	USB	Encoder
Red	Disconnected	Reference mark found
Yellow	Connected	Encoder not moving
Green	Communication in progress	Encoder moving

Connections

Pin	Function
1	GND (0 V)
2	Z+
3	B+
4	A+
5	5 V
6	Z-
7	B-
8	A-
9	GND (0 V)

Connections are directly compatible with the pin-out for RLS encoders. When used with Renishaw encoder, the encoder pin-out might need to be modified.

Software for E201-9Q

1. Open the software and wait for the device to be found.

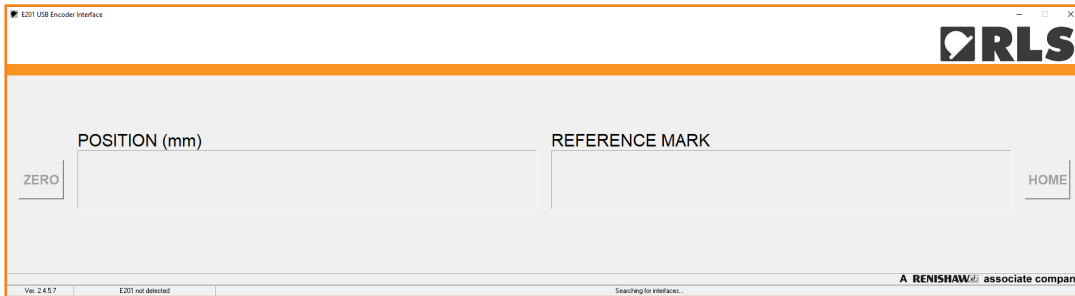

2. At the bottom of the interface click on text that says (Double click to change) to enter settings.

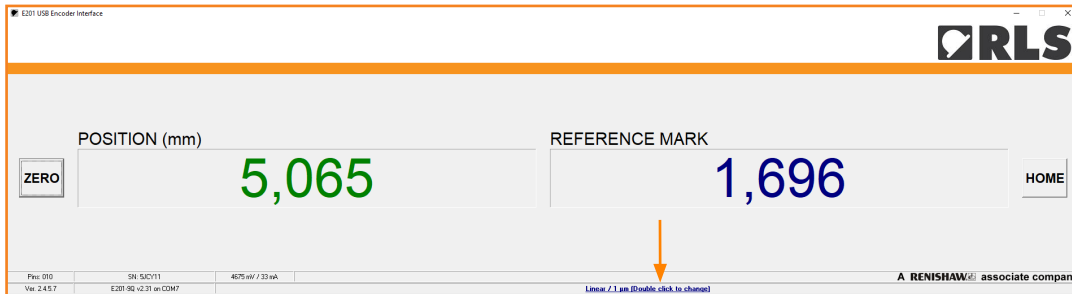

3. In the settings fill out data according to data sheet of the encoder you are using.

Select type of the encoder →

Resolution of the connected encoder:
- Linear: distance between counts
- Rotary: Number of counts per revolution

This section is enabled by checking the box "Distance Coded Ref Marks". Fill it out according to the data sheet of the encoder you are using.

Select preferred units for display →

E201 Settings

Encoder Type
 Linear Rotary Distance Coded Ref Marks

Encoder Interface
 SSI Grey BiSS

SSI Frequency
 140 kHz

Resolution
 1 μ m

SSI / BiSS Mode Settings
 Padding bits: 0 Status bits: 0 Detail_status: 0 CRC bits: 6

Distance Coded Reference Marks Settings
 Nominal Increment (Periods): 1000 Counts Per Period: 20
 Basic Increment K (mm): 2000 Periode Lenght (mm): 2

Show Reference Marks

Display Unit - Linear
 mm Inch
 μ m mil

Encoder Status
 Show Encoder Status
 Show Status Colors
 Active Status LOW

Direction
 Invert Direction

E201 Interface Status
 Show E201 Status Info

Recording data
 Capture positions to a list
 Save position to a file every 1 seconds

OK Cancel

Ver. 2.4.5.7 / E201-9Q v2.31

Check this box if your encoder has a distance coded reference mark to enable "Distance Coded Reference Mark Settings"

Encoder power supply, current consumption and input pins status.

Communications

The E201 interface responds to ASCII commands received over the USB acting as a virtual serial port. No CR character is required after any command. Speed settings of the virtual serial port can be any value.

E201-9Q Command set

This section is only required if you want to develop your own software. The E201 comes with basic display software described in the previous chapter.

Ascii command	Action	Interface response (with example)
v	E201-9Q returns software version + CR	E201-9Q V2.31 + CR
s	Internal serial number in 8 Hex numbers	(0029002d : 55345712 : 20363236 + CR) aaaaaaaa : bbbbbbbb : ccccccc + CR
r	Interface product serial number (6 characters; written on Interface housing)	(51X499 + CR) nnnnnn + CR where: n = product serial number
?	Encoder position E201-9Q returns 3 decimal values (width not fixed) separated by colons and terminated with CR	(3412:2596:1 + CR9 nnnn:rrrr:ssss + CR where: n = encoder count r = count value when reference/index was last seen s = status (status value of 1 shows that a reference was detected – use ‘c’ command to clear)
!	Encoder position E201-9Q returns 4 decimal values (width not fixed) separated by colons and terminated with CR	(3412:2596:1:3574 + CR) nnnn:rrrr:ssss:tttt + CR where: n = encoder count r = count value when reference/index was last seen s = status (status value of 1 shows that a reference was detected – use ‘c’ command to clear) t = timestamp of position in μ s Note: available in E201 interface version 1.18 (and later)
>	Encoder position E201-9Q returns 24 character hexadecimal string + CR comprising 3 sets of 8 character hexadecimal strings	(0000d5400000a2400000001 + CR) nnnnnnnnrrrrrrrrrrrrssssssss + CR where: n = encoder count (signed 32 bit) r = count value when reference/index last seen (signed 32 bit) s = status (status value of 1 shows that a reference was detected – use ‘c’ command to clear)
<	Encoder position E201-9Q returns 32 character hexadecimal string + CR comprising 4 sets of 8 character hexadecimal strings	(0000000000000000000000003425fcd8 + CR) nnnnnnnnrrrrrrrrrrrrssssssstttttt + CR where: n = encoder count r = count value when reference/index was last seen s = status t = timestamp of position in μ s Note: Available in E201 interface version 1.18 (and later)

Command set continued

Ascii command	Action	Interface response (with example)
I	Begin Index mode. On every reference/index E201-9Q returns position as 8 character hexadecimal string	On command: no response On index: (I = 00000ec9 + CR) I = nnnnnnnn + CR where: n = encoder count on reference/index
i	Stop Index mode (stops returning position on every reference/index)	-
c	E201-9Q clears reference status flag	-
z	E201-9Q sets current count value to zero (this also affects reference mark position)	-
a	E201-9Q clears zero offset value stored by 'z' command	-
e	Read encoder supply status, voltage and current consumption (fixed width)	(1 : 4.975 V : 0070 mA + CR) s : a.aaa V : bbbb mA + CR
n	Turn on power supply to encoder (default at power-up)	ON + CR
f	Turn off power supply to encoder	OFF + CR
p	Status of hardware input pins on interface (0 or 1)	(110 + CR) abz + CR
1	Begin auto transmission of encoder position in decimal form at 500 Hz rate*	(1234 + CR) nnnn + CR
0	Stop auto transmission	-

* Interfaces with firmware v2.30 and older transmit at 1 kHz, which can overload the USB connection in some cases. In this case, E201 no longer responds and must be disconnected and reconnected.

E201-9S – for 5 V absolute SSI and BiSS C unidirectional encoders

The E201-9S interrogates an SSI or BiSS encoder and allows the data to be read by a PC using simple ASCII commands over the USB connection.

Software installation

Download and install the [Software for E201-9Q and E201-9S](#). To install drivers, follow the steps in the following chapter. When the installation is complete, connect the E201 interface and configure the software for the encoder you are using. The supply voltage and current consumption of the encoder can be read by the software. The encoder's power supply can be turned on and off by the software.

A detailed explanation of the ASCII commands for the development of customised software can be found in chapter [Command set](#).

Installing the USB drivers

USB drivers For Windows 10 or newer, use Windows Update to install "inbox drivers". For more information see [link](#). For Windows 8 or older, or if inbox driver installation fails, drivers must be downloaded from [RLS Media center](#).

The E201 interface appears as a new Virtual COM port on the computer. The actual port number assigned depends on how many COM ports are already in use on the PC.

In Windows you can find this under:

Control Panel > System > Device Manager > Ports (COM & LPT)

Supported operating systems: 32-bit and 64-bit Windows (XP, Vista, 7 and 8/8.1, 10, 11) Linux and Mac OS X. The E201 USB interface should be automatically detected on Linux and Mac OS X.

It uses the "Communication Device Class driver (CDC)".

VID = 0483 & PID = 5740

Technical specifications

Power supply	5 V over USB port
Power consumption	65 mA (without encoder connected)
Encoder power supply	5 V or lower as supplied from the computer. Consider voltage drop over USB cable, USB hubs and encoder cable. Output is fused.
Data outputs	Clock/MA (differential pair – RS422)
Data inputs	Data/SLO (differential pair – RS422)
Encoder connector	D-Sub 9 pin, female
USB connector	USB 1.1 Full Speed; USB 5 pin mini-B connector
Drivers	Windows, Linux, Mac
Cable length	1 m standard A to mini-B USB cable (supplied). Maximum length 5 m.
Operating temperature	0 °C to +45 °C
Environmental sealing	IP20 – indoor use only
Mass	42 g (interface without USB cable)

Status LEDs

LED colour	USB	Encoder
Red	Disconnected	Encoder not connected
Yellow	Connected	-
Green	Communication in progress	Encoder connected

Connections

Pin	Function	
	SSI encoder	BiSS encoder
1	GND (0 V)	GND (0 V)
2	Clock+	MA+
3	Clock-	MA-
4	NC	NC
5	5 V	5 V
6	Data+	SLO+
7	Data-	SLO-
8	NC	NC
9	GND (0 V)	GND (0 V)

BiSS is hardware compatible with SSI.

Connections are directly compatible with the pin-out for RLS encoders. When used with Renishaw encoder, the encoder pin-out might need to be modified.

Software for E201-9S

1. Open the software and wait for the device to be found.

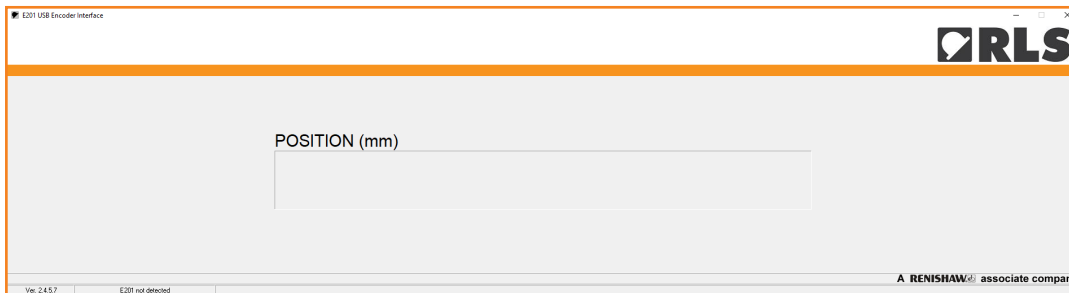

2. At the bottom of the interface click the “(Double click to change)” to enter settings.

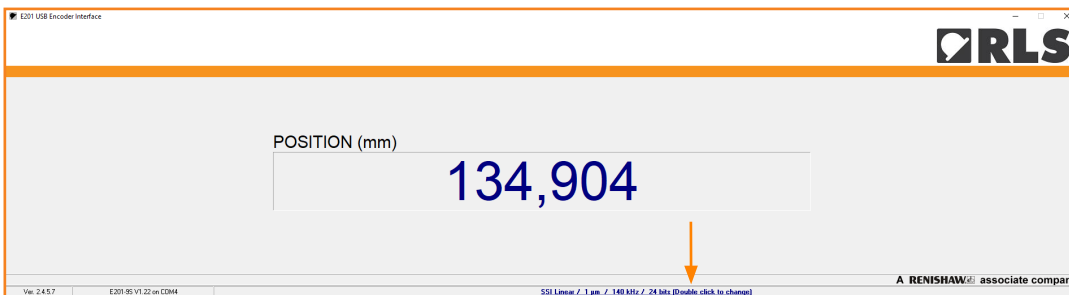

3. In the settings fill out data according to data sheet of the encoder you are using.

The screenshot shows the 'E201 Settings' dialog box with several sections and annotations:

- Encoder Type:** Radio buttons for 'Linear' (selected), 'Rotary', and 'Distance Coded Ref Marks'.
- Encoder Interface:** Radio buttons for 'SSI' (selected), 'Gray', and 'BiSS'.
- SSI Frequency:** A dropdown menu set to '140 kHz'.
- Resolution:** A dropdown menu set to '1'.
- Position Data (Bits):** A dropdown menu set to '24'.
- SSI / BiSS Mode Settings:** Four spinners for 'Padding bits', 'Status bits', 'Detail. status', and 'CRC bits', all set to '0'.
- Distance Coded Reference Marks Settings:**
 - 'Nominal Increment (Periods)': 1000
 - 'Counts Per Period': dropdown set to 2
 - 'Basic Increment K (mm)': 2000
 - 'Periode Lenght (mm)': radio buttons for '2' (selected) and '5'.
 - 'Show Reference Marks': checked.
- Display Unit - Linear:** Radio buttons for 'mm' (selected), 'Inch', 'µm', and 'mil'.
- Encoder Status:**
 - 'Show Encoder Status': unchecked
 - 'Show Status Colors': unchecked
 - 'Active Status LOW': checked
- Direction:** 'Invert Direction' unchecked.
- E201 Interface Status:** 'Show E201 Status Info' checked.
- Recording data:**
 - 'Capture positions to a list': unchecked
 - 'Save position to a file every': spinner set to '1' seconds.

Annotations with orange arrows point to these settings:

- 'Select type of the encoder' points to the Encoder Type section.
- 'Select interface of the encoder' points to the Encoder Interface section.
- 'Fill in according to communication section in data sheet of the encoder you are using' points to the Resolution and Position Data (Bits) sections.
- 'Select preferred units for display' points to the Display Unit - Linear section.
- 'Standard settings for BiSS C compliant encoders: - Status bits: 2 - CRC bits: 6 - Active status Low (checked)' points to the SSI / BiSS Mode Settings and Encoder Status sections.
- 'Encoder power supply, current consumption and input pins status.' points to the E201 Interface Status section.

Communications

The E201 interface responds to ASCII commands received over the USB acting as a virtual serial port. No CR character is required after any command. Speed settings of the virtual serial port can be any value.

E201-9S Command set

This section is only required if you want to develop your own software. The E201 comes with basic display software.

Ascii command	Action	Interface response (with example)	SSI encoder	BiSS encoder
v	E201-9S returns software version + CR	E201-9S V1.22 + CR	✓	✓
s	Internal serial number in 8 Hex numbers	(0029002d : 55345712 : 20363236 + CR) aaaaaaaa : bbbbbbbb : cccccccc + CR	✓	✓
r	Interface product serial number (6 characters; written on Interface housing)	(78J077 + CR) nnnnnn + CR where: n = product serial number	✓	✓
?	Encoder position E201-9S returns encoder position in decimal representation (width not fixed)	(1234 + CR) nnnn + CR where: n = encoder count	✓	
>	Encoder position E201-9S returns 8 Hex digits with encoder position	(00000d54 + CR) nnnnnnnn + CR where: n = encoder count (signed 32 bit)	✓	
!	Encoder position E201-9Q returns 2 decimal values (width not fixed) separated by colon and terminated with CR	(1234:5678 + CR) nnnn:tttt + CR where: n = encoder count t = position timestamp in µs	✓	
4	Encoder position E201-9S returns 16 character hexadecimal string + CR comprising 64 SLO bits, synchronised to 64 MA clocks Used for BiSS C-mode (unidirectional) encoders Note: Available in E201 interface version 1.16 (and later)	(c004c9ba71753000 + CR) nnnnnnnnnnnnnnnn + CR where: n = SLO bits in 16 Hex digits, comprising Ack, Start, Cds (always '0') in BiSS C mode (unidirectional), Position, Status and CRC bits.*		✓
b	Read current word width that is read from encoder	(31 bit + CR) nn bit + CR	✓	
Bnn+CR	Set word width; n can be one or two characters	(OK 31 bit + CR or B param error + CR) OK nn bit + CR N = 1 to 31	✓	
m	Read current encoder clock frequency	3 = 140 kHz + CR or 9 = ERROR n = xxx kHz + CR	✓	✓
Mn	Set SSI and BiSS clock frequency: 8 = 4.4 MHz 7 = 2.2 MHz 6 = 1.1 MHz 5 = 560 kHz 4 = 280 kHz 3 = 140 kHz (default) 2 = 70 kHz 1 = 35 kHz	(frequency 5 + CR or M param error + CR) frequency n + CR where: n = 1 to 7	✓	✓

Command set continued

Ascii command	Action	Interface response (with example)	SSI encoder	BiSS encoder
e	Read encoder supply status, voltage and current consumption (fixed width)	(1 : 4.975 V : 0070 mA + CR) s : a.aaa V : bbbb mA + CR	✓	✓
n	Turn on power supply to encoder (default at power-up)	ON + CR	✓	✓
f	Turn off power supply to encoder	OFF + CR	✓	✓
p	Status of hardware input pins on interface	(_11 + CR) xcd + CR x = space character c = clock pin (0 or 1), should be 1 d = data pin (0 or 1), should be 1	✓	✓
1	Begin auto transmission of encoder position in decimal form at 500 Hz rate	(1234 + CR) nnnn + CR	✓	
0	Stop auto transmission	-	✓	

* Reading BiSS C position

The user must decode the SLO bits into Position, Status and CRC according to the corresponding bit lengths. Eg.: If the Position, Status and CRC length is 26 bits, 2 bits and 6 bits respectively, the response c004c9ba71753000 is decoded as 0x19374E2 (Position), 0x03 (Status) and 0x2A (CRC, $x^6 + x^1 + 1$ polynomial, inverted).

Additional information can be found in the document E201D02 at [RLS Media center](#).

Verifying the BiSS data structure and CRC can be simplified using the BiSS CRC calculator tool at [RLS media center](#).

E201-9B – for BiSS C bidirectional encoders

The E201-9B interrogates a BiSS C encoder and allows the data to be read by a PC using simple ASCII commands over the USB connection.

Software installation

Download and install the **EncoSight v4 software** and USB drivers. To install drivers, follow the steps in the following chapter. When the installation is complete, connect the E201 interface and configure the software for the encoder you are using. The supply voltage and current consumption of the encoder can be read by the software. The encoder's power supply can be turned on and off by the software.

A detailed explanation of the ASCII commands for the development of customised software can be found in chapter **Command set**.

Installing the USB drivers

USB drivers can be downloaded from **RLS Media center**.

The E201 interface appears as a new Virtual COM port on the computer. The actual port number assigned depends on how many COM ports are already in use on the PC.

In Windows you can find this under:

Control Panel > System > Device Manager > Ports (COM & LPT)

Supported operating systems: 32-bit and 64-bit Windows (XP, Vista, 7 and 8/8.1, 10, 11)* Linux** and Mac OS X. The E201 USB interface should be automatically detected on Linux and Mac OS X.

It uses the "Communication Device Class driver (CDC)".

VID = 0483 & PID = 5740

* Windows CE and Embedded do not have all files in the "Windows" folder for proper driver installation. Additional files must be copied from other Windows Desktop system.

** The E201 is Linux compatible as it uses a generic CDC driver, but this has not been tested internally and no support is available.

Technical specifications

Power supply	5 V over USB port
Power consumption	65 mA (without encoder connected)
Encoder power supply	5 V or lower as supplied from the computer. Consider voltage drop over USB cable, USB hubs and encoder cable. Output is fused.
Data outputs	Clock/MA (differential pair – RS422)
Data inputs	Data/SLO (differential pair – RS422)
Encoder connector	D-Sub 9 pin, female
USB connector	USB 1.1 Full Speed; USB 5 pin mini-B connector
Drivers	Windows, Linux, Mac
Cable length	1 m standard A to mini-B USB cable (supplied). Maximum length 5 m.
Operating temperature	0 °C to +45 °C
Environmental sealing	IP20 – indoor use only
Mass	42 g (interface without USB cable)

Status LEDs

LED colour	USB	Encoder
Red	/	Power off
Yellow	/	Power on
Green	Power on	Communication active

Connections

Pin	Function
	BiSS encoder
1	GND (0 V)
2	MA+
3	MA-
4	NC
5	5 V
6	SLO+
7	SLO-
8	NC
9	GND (0 V)

Connections are directly compatible with the pin-out for RLS encoders. When used with Renishaw encoder, the encoder pin-out might need to be modified.

Software for E201-9B: EncoSight v4

Software is only available for encoders with bidirectional BiSS C and a valid Electronic Data Sheet (EDS) in the encoder.

1. Download the software at **RLS Media center**. No installation is required. Open the software and wait until the E201 device is found. If the connection is not established after a few seconds, make sure that you have installed the correct driver set, see chapter **Installing the USB drivers**.

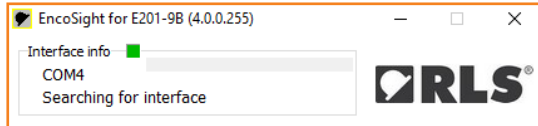

2. Under "Interface settings" you can check encoder voltage and current readout. You can also change the BiSS frequency and switch the encoder power supply on and off. Here is also a list of responses to all ASCII commands. For more details see chapter **E201-9B Command set**.

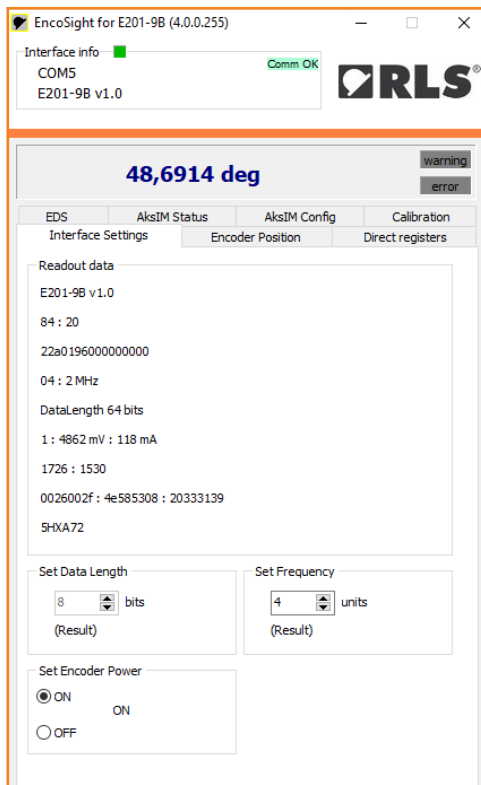

3. Basic encoder BiSS-related configuration is available in “Direct Registers” section. Parameters for identifying the encoder are also listed here, such as part number, serial number and firmware version.

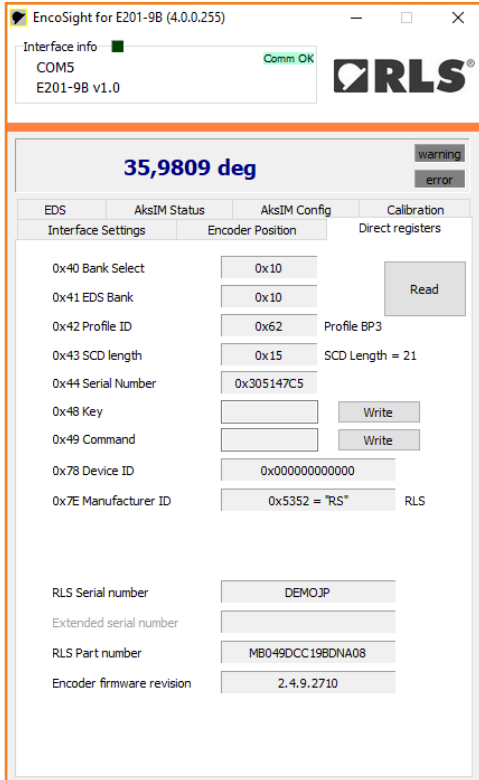

4. The “Encoder Position” section displays the raw BiSS frame received from the encoder (in hexadecimal and binary), the conversion factors to degrees (for rotary encoders) or millimeters (for linear encoders), and the raw encoder count values. By default, the EncoSight software automatically configures the number of bits for multiturn and singleturn based on the values stored in the encoder’s Electronic Data Sheet (EDS). These are set at first connection to the encoder. However, if necessary, you can also configure these settings manually. Both values should be set according to the encoder’s data sheet.

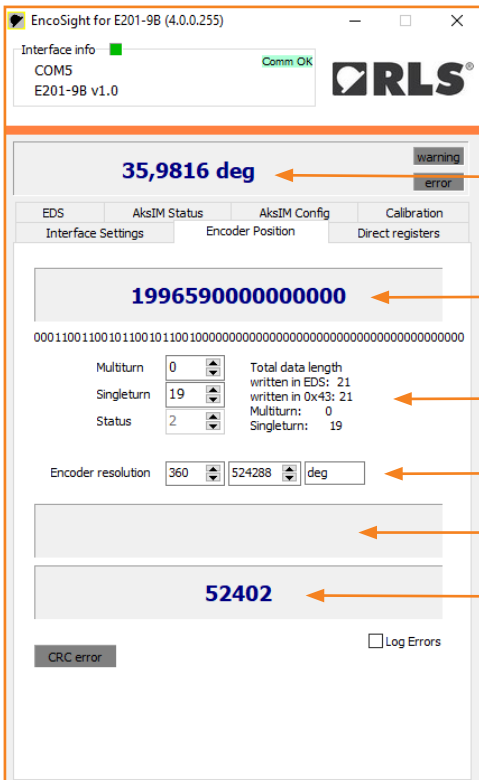

When using the encoders with built-in Electronic Data Sheet (EDS), these settings are automatically populated.

Encoder position
 Data read from the encoder (in hex)
 Data read from the encoder (in binary)
 Number of bits in the BiSS frame
 Conversion from counts to display value (nominator, denominator, unit of measure)
 Multiturn counter
 Singleturn position (in counts)

5. To reset the multiturn counter, set a new zero point, or reset the encoder to factory settings, go to "AksIM Config" or "Orbis Config"* as shown in the picture below. Factory reset function resets the zero position, error map, filters and self-calibration. You can set the zero position to the current encoder position by clicking on "set zero here". If you want to set the position manually, you can do this using the following procedure: Read the current zero offset. Write the desired position offset (unit: encoder counts). The value must be between 0 and the maximum encoder count value. Press the Write button. This number is subtracted from the absolute encoder position. Zero position offset is stored in the encoder itself.

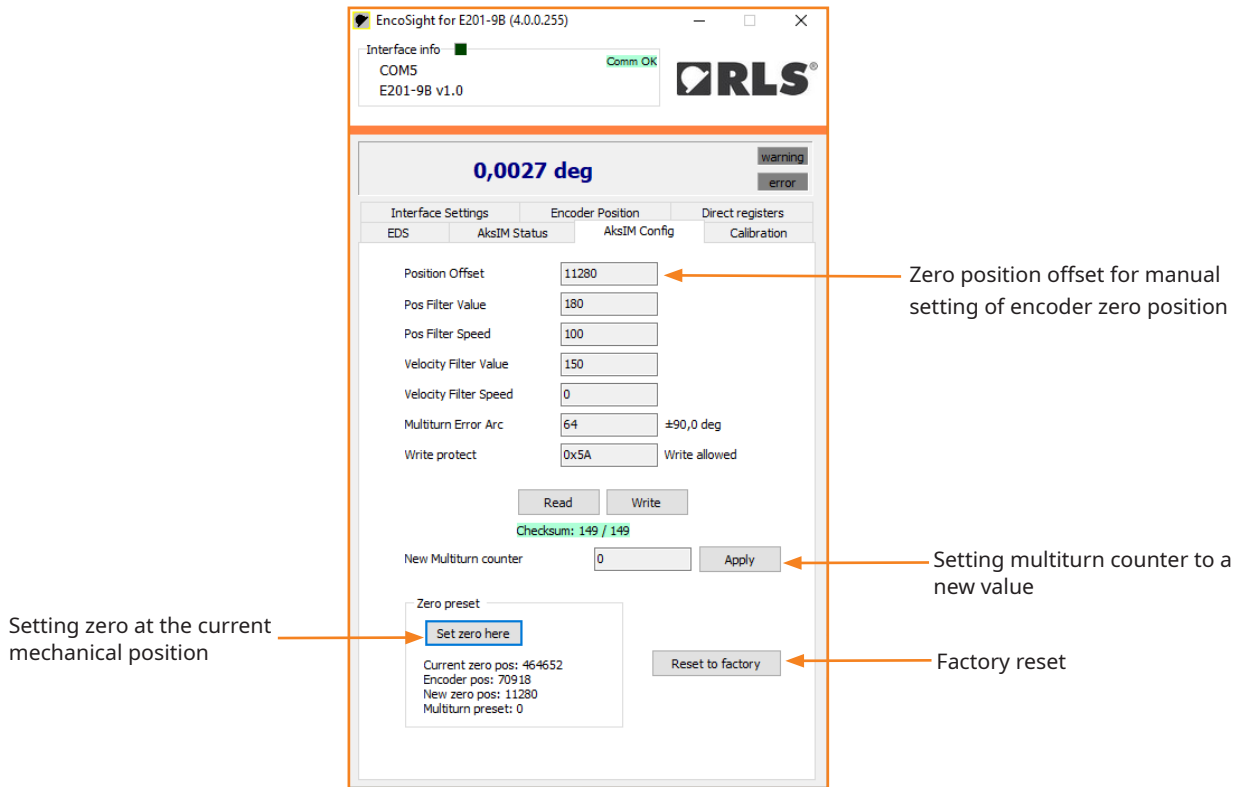

* The name may vary depending on the name of the encoder used.

6. The “AksIM Status” or “Orbis Status” section is present when one of these encoders is connected. It displays the real-time operation status of the encoder and shows possible errors or warnings, which can also be logged for further analysis. The air gap, i.e. the distance between the readhead and the magnetic ring, is calculated and displayed. With the “Draw” option, air gap will be plotted throughout the full rotation, to verify that it stays within the mounting tolerances. The “Copy” function prepares installation data in the text form and places it into the clipboard for logging into the external database. Persistent status (if supported by the encoder) accumulates all the detailed status bits since the encoder power-up and can be very useful for troubleshooting intermittent problems with the system.

The screenshot shows the EncoSight interface for an E201-9B encoder. The main display shows a position of 338,2553 deg. Below this, there are tabs for Interface Settings, Encoder Position, and Direct registers. The AksIM Status tab is active, showing various status bits like Sensor Init, Temperature, Signal Level, and Velocity. A detailed status table is visible, listing Error and Warning conditions. The Air gap is shown as 172 μm (±20 μm). A graph at the bottom plots the air gap over 360 degrees, with horizontal lines indicating error and warning limits. A 'Copy' button is present for the status data.

Annotations:

- Detailed status bits read from the encoder
- Visualized status bits
- Double-click on “Air gap” text to set the new zero position (on touch)
- Calculates statistical data from the measured data plot and places prepared short report onto the clipboard.
- Error limit
- Warning limits

7. To ensure optimal performance of the encoder, it is possible to perform a self-calibration in the “Calibration” menu. For more information about the self-calibration function, refer to the data sheet of the connected encoder.

The left screenshot shows the Calibration menu with a position of 250,1992 deg. It includes fields for Calibration arc length (360 deg) and Calibration Timeout. A 'Start calibration' button is visible. The self-calibration status list shows 'Procedure finished' and 'Calibration successful'. The right screenshot shows the same menu after calibration, with a position of 35,9789 deg. The self-calibration status list is updated with 'Calibration successful' highlighted in green. A 'Copy' button is present at the bottom right of the status list.

Annotation:

- Places calibration results onto the clipboard.

Communications

The E201 interface responds to ASCII commands received over the USB acting as a virtual serial port. No CR character is required after any command. Speed settings of the virtual serial port can be any value.

E201-9B Command set

This section is only needed if you want to develop your own software. The E201 comes with the basic display software described in the previous chapter.

Connecting to the interface:

1. Install the USB drivers as described in chapter [Installing the USB drivers](#).
2. Verify correct installation in Windows Device manager.
3. Sending the command “v” via the correct COM port will return the E201 type and Firmware version.

Ascii command	Action	Interface response (with example)
v	E201-9B returns software version + CR	E201-9B V1.0 + CR
s	Internal serial number in 8 Hex numbers	(0029002d : 55345712 : 20363236 + CR) aaaaaaaa : bbbbbbbb : cccccccc + CR
r	Interface product serial number (6 characters; written on Interface housing)	(78J077 + CR) nnnnnn + CR where: n = product serial number
4	Encoder position E201-9B returns 16 character hexadecimal string Decode according to document (E201D02)	(00181907FD606002 + CR) nnnnnnnnnnnnnnnn + CR where: n = SLO bits in 16 Hex digits, comprising Position, Status and CRC bits.
m	Read current encoder clock frequency	(3 : 140 kHz + CR or 16 = ERROR) n : xxx kHz + CR
Mxy	Set BiSS frequency. xy is a parameter from 00 to 31, excluding 16. They correspond to frequencies from 63 kHz to 10 MHz. Default after reset is 2 MHz. To check the set frequency use command m. Set SSI and BiSS clock frequency:	(frequency 5 + CR or M param error + CR) frequency x + CR
e	Read encoder supply status, voltage and current consumption (fixed width)	(1 : 4.975 V : 0070 mA + CR) s : a.aaa V : bbbb mA + CR
N	Turn on power supply to encoder (default at power-up)	ON + CR
F	Turn off power supply to encoder	OFF + CR

Reading position:

1. Send command “4”.
2. Wait for data until CR character is received (must be 17 bytes).
3. Encoder BiSS timeout error” is received, if encoder is disconnected.
4. Received value is in HEX.
5. Decode according to the document E201D06 at [RLS Media center](#).

Accessing BiSS C registers:

Use the application notes of **AksIM-2 (MBD02)** and **Orbis (BRD05)** encoders to find out the correct registers and memory layout. Note that the BiSS registers are in Big endian format.

TX	RX	Command explanation
Rxy:abc	S:nn:dddd... , where S is status, nn is details and dddd... are requested data bytes. 0:00 - ok, 1:xy - End of bank reached 2 - CRC error or incorrect data length 3 - address > 127 or number of bytes > 64 or zero 4 - timeout (example: 0:00:0218)	Read xy (decimal) number of bytes, starting on address abc (decimal).
WsQWE:abc	S 0 - ok 1 - non-writable address 2 - CRC error or incorrect data length 3 - address > 127 or no communication 4 - timeout during communication	Write single register. Write byte QWE (decimal) into address abs (decimal).

E201-9P – for SPI EncoLink and PWM encoders

The E201-9P interrogates a SPI or PWM encoder and allows the data to be read by a PC using simple ASCII commands over the USB connection. Also supports complete functionality of the EncoLink protocol over SPI interface.

Software installation

Download and install the [EncoLink software](#) and USB drivers. To install drivers, follow the steps in the following chapter. When the installation is complete, connect the E201 interface and configure the software for the encoder you are using. The supply voltage and current consumption of the encoder can be read by the software. The encoder's power supply can be turned on and off by the software.

A detailed explanation of the ASCII commands for the development of customised software can be found in chapter [Command set](#).

Installing the USB drivers

USB drivers can be downloaded from the [RLS Media center](#).

The E201 interface appears as a new Virtual COM port on the computer. The actual port number assigned depends on how many COM ports are already in use on the PC.

In Windows you can find this under:

Control Panel > System > Device Manager > Ports (COM & LPT)

Supported operating systems: 32-bit and 64-bit Windows (XP, Vista, 7 and 8/8.1, 10, 11)* Linux** and Mac OS X. The E201 USB interface should be automatically detected on Linux and Mac OS X.

It uses the "Communication Device Class driver (CDC)".

VID = 0483 & PID = 5740

* Windows CE and Embedded do not have all files in the "Windows" folder for proper driver installation. Additional files must be copied from other desktop systems.

** The E201 is Linux compatible as it uses a generic CDC driver, but this has not been tested internally and no support is available.

Technical specifications

Power supply	5 V over USB port
Power consumption	65 mA (without encoder connected)
Encoder power supply	5 V or lower as supplied from the computer. Consider voltage drop over USB cable, USB hubs and encoder cable. Output is fused.
Data outputs	NCS, SCK, MOSI (3.3 V LVTTTL)
Data inputs	MISO, PWM, Status (3.3 V LVTTTL)
Encoder connector	D-Sub 9 pin, female
USB connector	USB 1.1 Full Speed; USB 5 pin mini-B connector
Drivers	Windows, Linux, Mac
Cable length	1 m standard A to mini-B USB cable (supplied). Maximum length 5 m.
Operating temperature	0 °C to +45 °C
Environmental sealing	IP20 – indoor use only
Mass	42 g (interface without USB cable)

Status LEDs

LED colour	USB	Encoder
Red	/	Power off
Yellow	/	Power on
Green	Power on	Communication active

Connections

Pin	Function	
	SPI	PWM
1	GND (0 V)	GND (0 V)
2	SCK	Status
3	(DNC)	(DNC)
4	Status	(DNC)
5	5 V	5 V
6	MISO	PWM
7	MOSI	(DNC)
8	(DNC)	(DNC)
9	GND (0 V)	GND (0 V)

DNC = Do Not Connect (leave floating)

Connections are directly compatible with the pin-out for RLS encoders. When used with Renishaw encoder, the encoder pin-out might need to be modified.

Software for E201-9P: EncoSight for AksIM SPI EncoLink

Currently only AksIM-2 and AksIM-4 encoders are supported. For other encoders **contact RLS**.

1. Download the software at **RLS Media center**. No installation is required. Open the software and wait until the E201 device is found. If the connection is not established after a few seconds, make sure that you have installed the correct driver set, see chapter **Installing the USB drivers**.

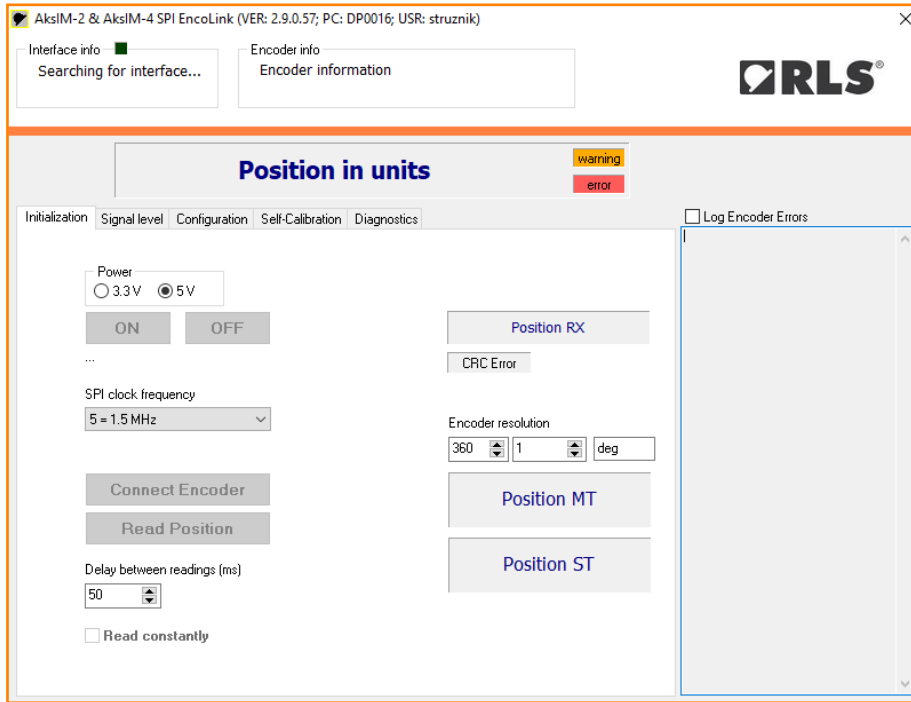

2. When the interface is found, first select power type of your encoder and then press "ON" (your encoder will turn on). Then connect the encoder and press "Read Position" (if you want to have a constant information about the position check the box "Read constantly").

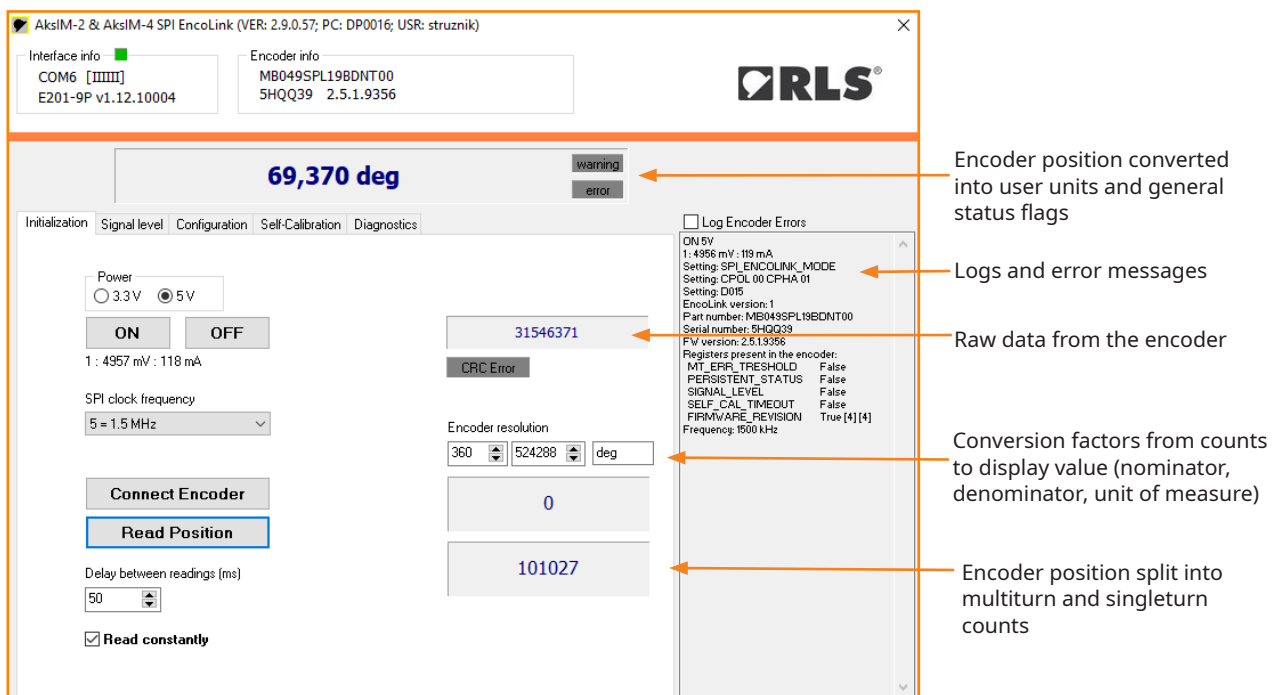

3. Air gap and temperature of the encoder can be logged in the section "Signal level" (check the boxes first). Errors can be logged for further analysis.

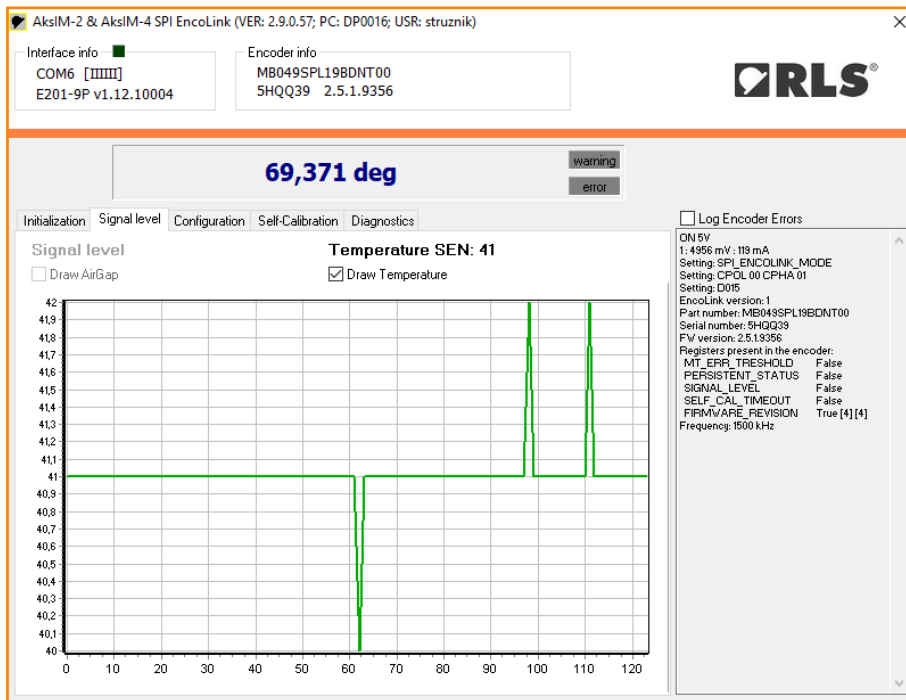

4. To preset the multiturn counter, set a new zero point or reset the encoder to the factory settings, go to the "Config" tab. The "Factory Reset" function resets the zero position, error map, filters and self-calibration. You can set the zero position to the current encoder position by clicking on "Set zero here". If you want to set the position manually, you can do this using the following procedure: Read the current zero offset. Write the desired position offset (unit: encoder counts). The value must be between 0 and the maximum encoder count value. Press the "Write Zero" button. This number is subtracted from the absolute encoder position. Zero position offset is stored in the encoder itself. Store the settings permanently with the button "Save to NVRAM". "Factory Reset" button restores all settings, including the self-calibration data.

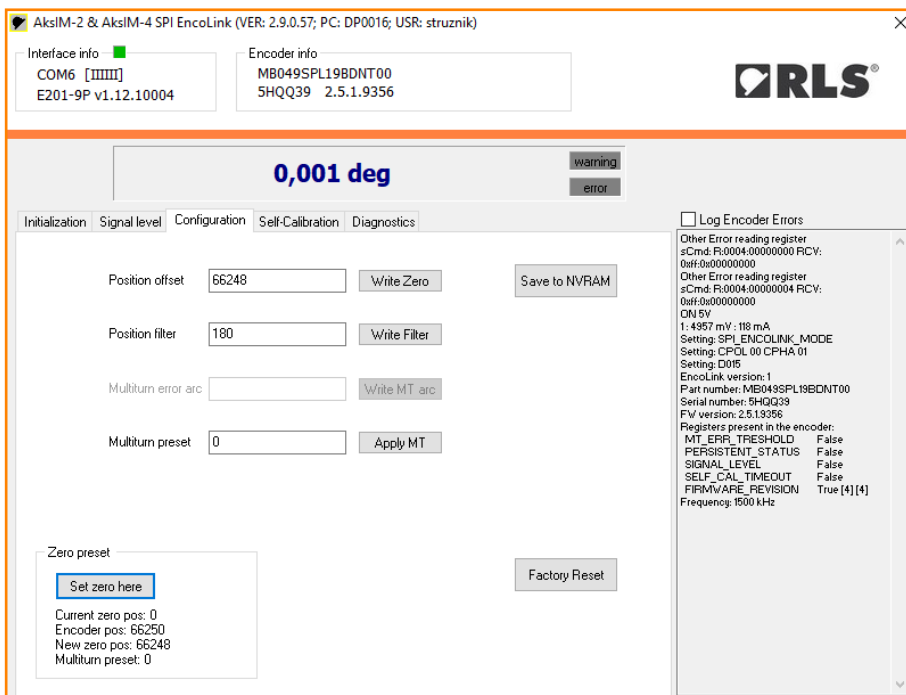

5. To ensure optimal performance of the encoder, it is possible to perform a self-calibration in the "Self-Calibration" section. For details refer to the encoder's data sheet MBD08 at [RLS Media center](#).

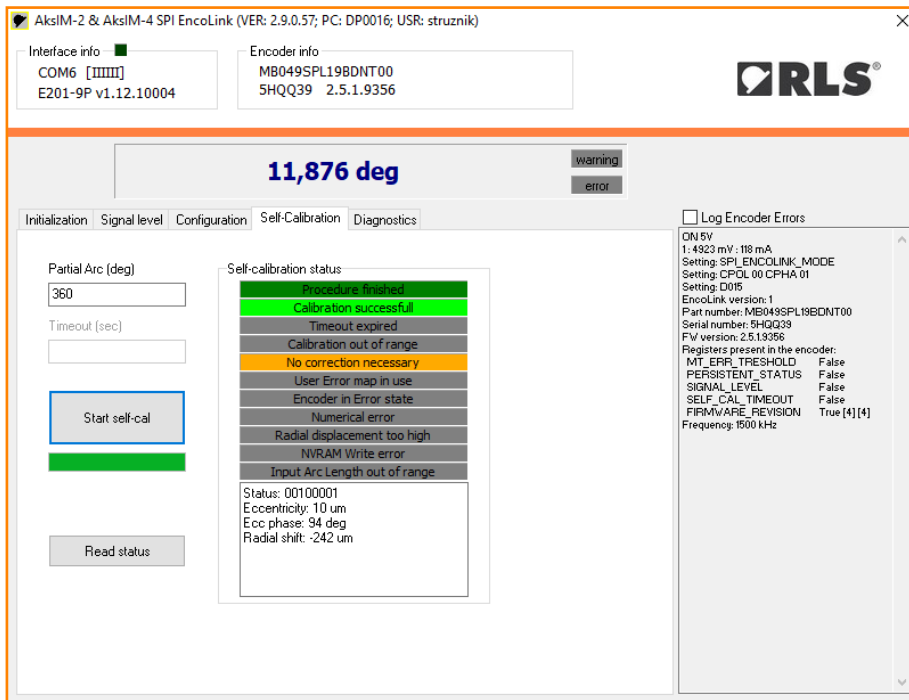

6. Diagnostics screen displays Detailed status bits, Persistent status bits and other data available in different encoder types. For details refer to the encoder's data sheet MBD08 at [RLS Media center](#).

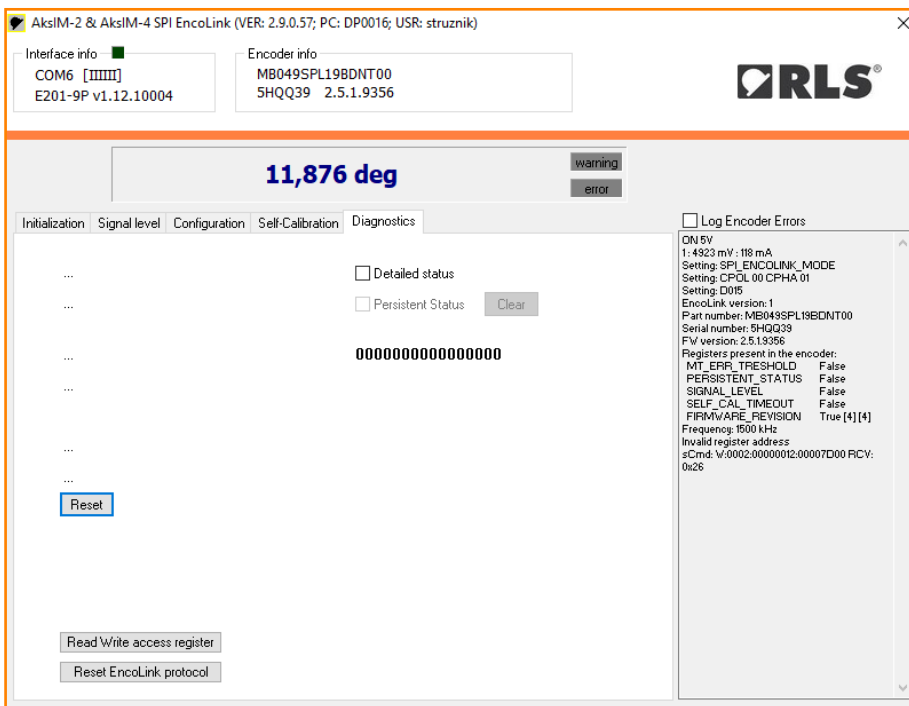

Communications

The E201 interface responds to ASCII commands received over the USB acting as a virtual serial port. No CR character is required after any command. Speed settings of the virtual serial port can be any value.

E201-9P Command set

This section is only needed if you want to develop your own software. The E201 comes with the basic display software described in the previous chapter.

Ascii command	Action	Interface response (with example)
v	E201-9Q returns software version + CR	E201-9P v1.13 + CR
s	Internal serial number in 8 Hex numbers	(0029002d : 55345712 : 20363236 + CR) aaaaaaaa : bbbbbbbb : ccccccc + CR
r	Interface product serial number (6 characters; written on Interface housing)	(51X499 + CR) nnnnnn + CR where: n = product serial number
o	Read E201 interface FW version	10008 + CR nnnnn = firmware commit number (decimal)
n	Turn on power supply to encoder (default at power-up is OFF)	ON 5V + CR or ON 3.3V + CR
f	Turn off power supply to encoder	OFF + CR
e	Get power supply data	(1 : 5004 mV : 130 mA + CR) x:yyyy mV : zzz mA + CR x = encoder is powered by E201 yyyy = supply voltage [mV] zzz = suply current [mA]
Vx	Set E201 output power supply x – power supply voltage 5 = 5 V 3 = 3.3 V	Vx (V5 + CR) (V3 + CR)
Cx	Select communication protocol x = version of communication protocol: e = SPI EncoLink s = SPI Simple p = SPI Advanced, Timestamp w = PWM input	SPI_ENCOLINK_MODE + CR

Command set continued

All SPI protocols

Ascii command	Action	Interface response (with example)
Gx:y	Set clock polarity and phase settings x = set SPI Clock Polarity 0 or 1 (default = 0) y = set SPI Clock Phase 0 or 1 (default = 1)	CPOL 00 CPHA 01 + CR
Mx	Set SPI clock frequency x - 1-8 clock* frequency: 1 = 94 kHz 2 = 187 kHz 3 = 375 kHz 4 = 750 kHz 5 = 1500 kHz 6 = 3 MHz 7 = 6 MHz 8 = 12 MHz	(Frequency 5 + CR) frequency n + CR where: n = 1 to 8
m	Return selected SPI frequency	(1500 kHz + CR or 3 MHz + CR) xxxx kHz + CR or yyyy MHz + CR x = 94, 187, 375, 750, 1500 y = 3, 6, 12
Dxxx	Delay between NCS falling edge and first SCK edge xxx = Delay in microseconds (decimal, including leading zeroes)	
?xx:yyy	Read encoder position xx = number of bytes to read from the encoder (decimal, including leading zeroes) yy = one byte (command) to send over MOSI line to the encoder (decimal, including leading zeroes) Data length: EncoLink single-turn: 04 EncoLink multi-turn: 06 SPI Simple: 02 SPI Advanced: 05 SPI Timestamp: 07	(57203dfe5 + CR) -ST (ffffe57203dfe5 + CR) -MT aaaabbbbbbccdd + CR**

* Although it is possible to set frequencies 7 and 8, RLS encoders are working up to 5 MHz.

** Decode according to the SPI timing diagram in the data sheet of the encoder you are using.

Command set continued

EncoLink protocol

Ascii command	Action	Interface response (with example)
j	Get EncoLink identification	(17MB049SPL19MDNT00 + CR) v n (p x16) + CR v = EncoLink version of the encoder n = number of bytes in a frame (to be used with command "?") p = 16 characters of encoder part number
R:xxxx:yyyyyyyy	EncoLink read register* x - register length (bytes) (HEX) y - register address (HEX)	(0x9:0x0001a154) + CR 0xA:0xBBBBBBBB A = read status** B = requested register contents (HEX)
W:xxxx:yyyyyyyy:zzzzzzz	EncoLink write register* x - register number of bytes (HEX) y - register address (HEX) z - data to be written (HEX)	(0x9) + CR 0xA + CR A = write status**

* Refer to the encoder's data sheet or application note for the register layout.

** Read / Write returned status:

- 0x9 = Completed OK
- 0x26 = Invalid register address
- 0x56 = Value out of range
- 0x96 = Access denied
- 0xEE = Incorrect number of bytes (register length mismatch)
- 0xF6 = Write access is locked
- 0xF9 = CRC invalid on write
- 0xE6 = CRC invalid on read

PWM protocol

Ascii command	Action	Interface response (with example)
w	Read PWM input	xxxxxxxx:yyyyyyyy:s + CR x - signal period (hex) y - high time (hex) s - status signal input (time unit = 1/48 μs)

Example - setting up the AksIM SPI EncoLink encoder

To initialize the connection with the EncoLink encoder, first send the following set of ASCII commands in this exact order:

v (check for E201 presence)
r (get interface serial number)
V5 (select 5 V power for the encoder)
n (enable power output)
e (verify current consumption)
Ce (enable EncoLink Master library in the E201)
G0:1 (set SCK polarity and phase)
D015 (set CS communication delay)
M7 (set clock frequency)
m (verify selected clock frequency)
j (initialize EncoLink library and get basic encoder parameters)

Example - communication with AksIM SPI EncoLink encoder

Read position, read register, write register

?04:000 (read 4 bytes of position data from the encoder (suitable for single-turn encoder))

?06:000 (read 6 bytes of position data from the encoder (suitable for multi-turn encoder))

R:0004:0000002B (read 4 byte long (U32) register at address 0x2B)

W:0002:0000004E:00000012 (write value 0x12 into 2 byte long (U16) register at address 0x4E)

Head office

RLS Merilna tehnika d. o. o.

Poslovna cona Žeje pri Komendi
Pod vrbami 2
SI-1218 Komenda
Slovenia

T +386 1 5272100
E mail@rls.si
www.rls.si

Global support

Visit our [website](#) to contact your nearest sales representative.

Document issues

Issue	Date	Page	Description
8	18. 4. 2024	-	New design
		22-30	E201-9P version added
		6, 11, 16-19, 24-26	Software user guide added
		7-8, 12-13, 20-21, 27-29	Programming commands added for versions B and P

This product is not designed or intended for use outside the environmental limitations and operating parameters expressly stated on the product's datasheet. Products are not designed or intended for use in medical, military, aerospace, automotive or oil & gas applications or any safety-critical applications where a failure of the product could cause severe environmental or property damage, personal injury or death. Any use in such applications must be specifically agreed to by seller in writing, and is subject to such additional terms as the seller may impose in its sole discretion. Use of products in such applications is at buyer's own risk, and buyer will indemnify and hold harmless seller and its affiliates against any liability, loss, damage or expense arising from such use. Information contained in this datasheet was derived from product testing under controlled laboratory conditions and data reported thereon is subject to the stated tolerances and variations, or if none are stated, then to tolerances and variations consistent with usual trade practices and testing methods. The product's performance outside of laboratory conditions, including when one or more operating parameters is at its maximum range, may not conform to the product's datasheet. Further, information in the product's datasheet does not reflect the performance of the product in any application, end-use or operating environment buyer or its customer may put the product to. Seller and its affiliates make no recommendation, warranty or representation as to the suitability of the product for buyer's application, use, end-product, process or combination with any other product or as to any results buyer or its customer might obtain in their use of the product. Buyer should use its own knowledge, judgment, expertise and testing in selecting the product for buyer's application, end-use and/or operating environment, and should not rely on any oral or written statement, representation, or samples made by seller or its affiliates for any purpose. EXCEPT FOR THE WARRANTIES EXPRESSLY SET FORTH IN THE SELLER'S TERMS AND CONDITIONS OF SALE, SELLER MAKES NO WARRANTY EXPRESS OR IMPLIED WITH RESPECT TO THE PRODUCT, INCLUDING ANY WARRANTY OF MERCHANTABILITY OR FITNESS FOR ANY PARTICULAR PURPOSE, WHICH ARE DISCLAIMED AND EXCLUDED. All sales are subject to seller's exclusive terms and conditions of sale which, where the seller is (a) RLS Merilna tehnika d. o. o., are available at <https://www.rls.si/eng/salesterms>, (b) Renishaw, Inc., are available at <https://www.renishaw.com/legal/en/-42186>, or (c) another person, are available on request, and in each case, are incorporated herein by reference, and are the exclusive terms of sale. No other terms and conditions apply. Buyer is not authorized to make any statements or representations that expand upon or extend the environmental limitations and operating parameters of the products, or which imply permitted usage outside of that expressly stated on the datasheet or agreed to in writing by seller.

RLS Merilna tehnika d. o. o. has made considerable effort to ensure the content of this document is correct at the date of publication but makes no warranties or representations regarding the content. RLS Merilna tehnika d. o. o. excludes liability, howsoever arising, for any inaccuracies in this document. © 2024 RLS d. o. o.